



S4

 *Infinity* S A U N A

· ASSEMBLY INSTRUCTIONS ·



Infinity SAUNA

ASSEMBLY INSTRUCTIONS

Before Getting Started:

1. Thoroughly read all instructions prior to installation.
2. When unpacking boxes, take extreme caution when handling all glass panels, especially door panel "G".

INCLUDED COMPONENTS • COMPOSANTS INCLUS • COMPONENTES INCLUIDOS

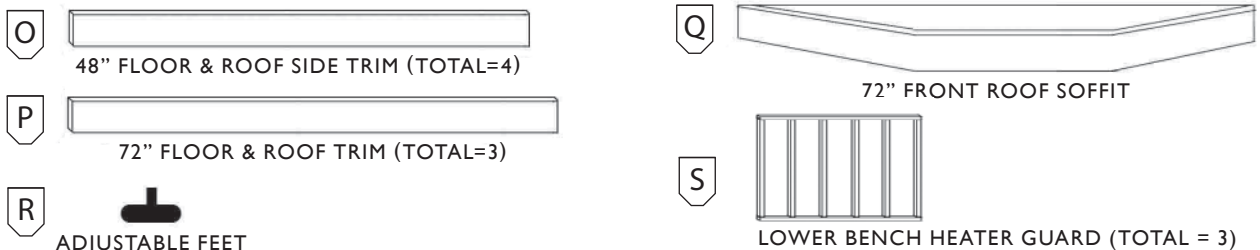
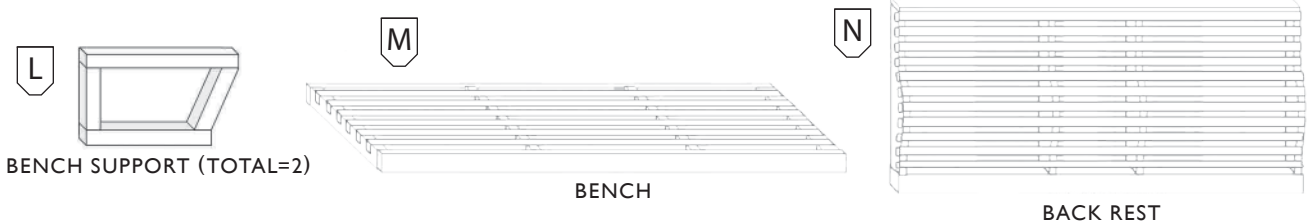
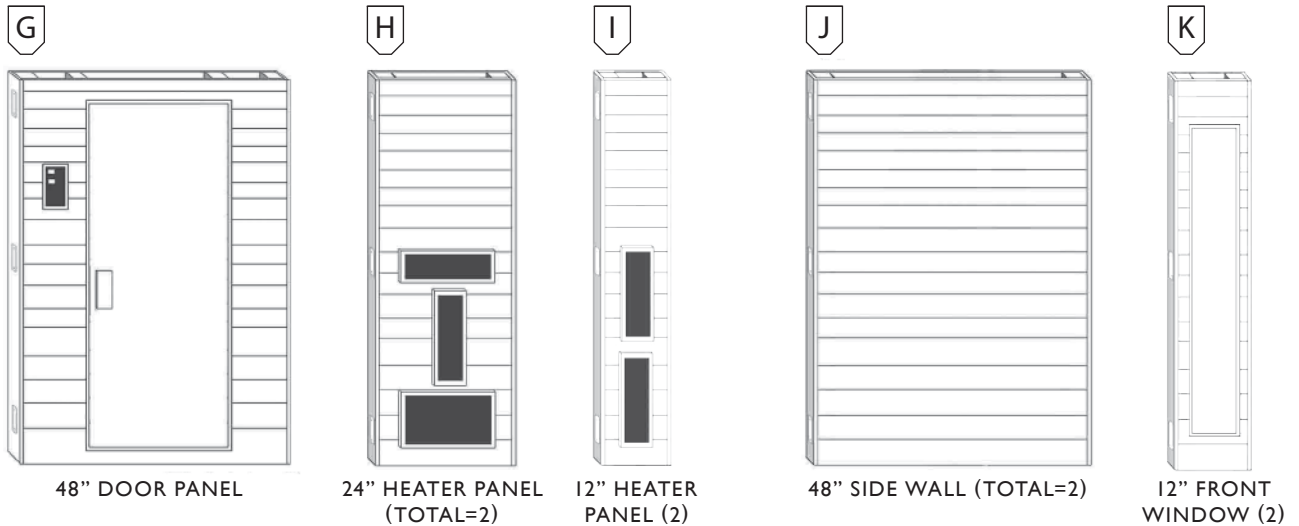
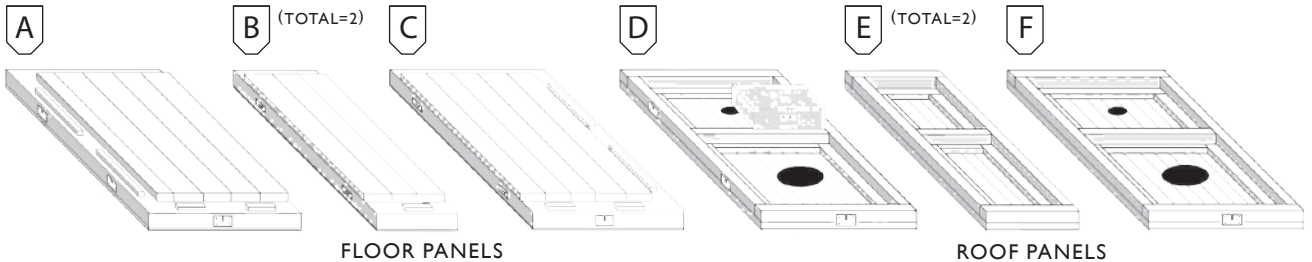

1

Before placing floor panels on ground, screw in adjustable feet “R” into each hole in bottom of floor panels.

IMPORTANT:
You must properly level the base panels or your sauna walls will not fit tightly together.

Once feet are screwed into floor panels, place panels on solid flat surface close to one another. Once level, connect the male/female plugs to lock panels together.

Male/Female plugs connect together.

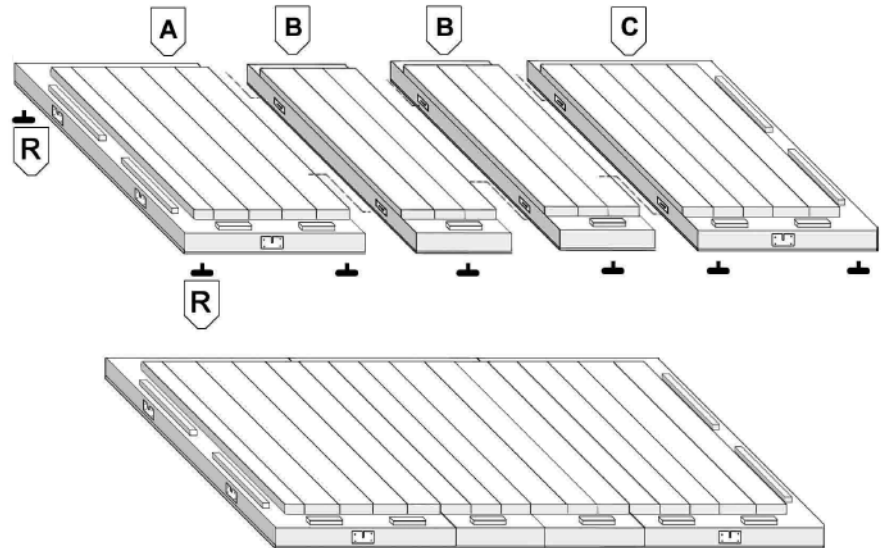

2

1. Slide trim pieces “P” (front and back) by aligning the slide lock brackets attached to the trim and sauna base. Applying downward pressure to connect and lock into place. Repeat for side trim “O”.

(Hint: If you are unable to join a pair of slide locks, use a Phillips head #2 screwdriver to slightly loosen the screws retaining the slide lock on the base.)

2. Place the completed base in the spot you intend to install your sauna.

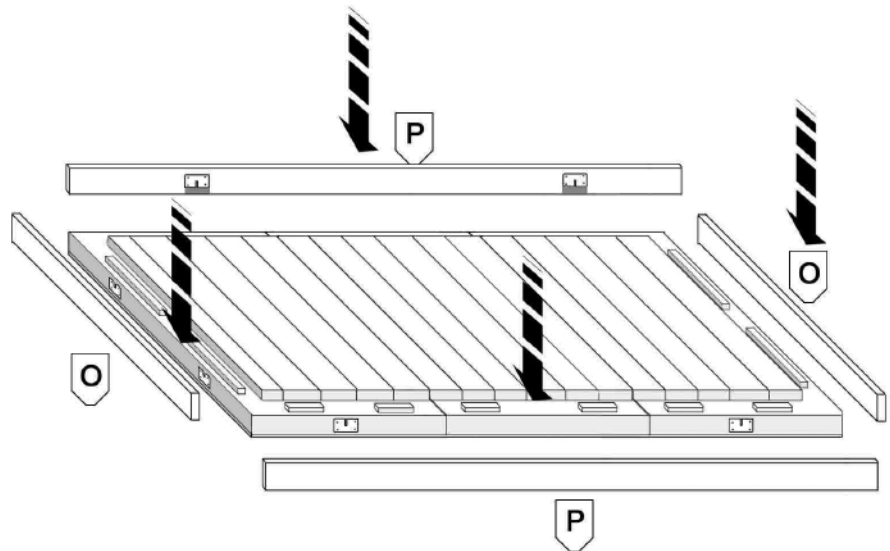

3

Notice the magnets on the wall. Make sure to place these facing inside the sauna unit.

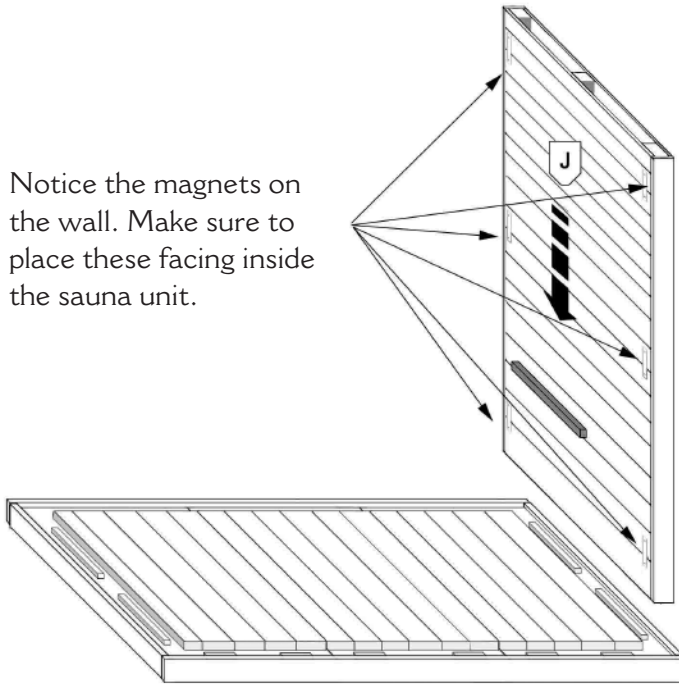

It is required to have two people for this and the following steps. Place a “J” panel into the right side base slot.

4

Use the “H” panel with metal clip on the right side, later used in back rest assembly.

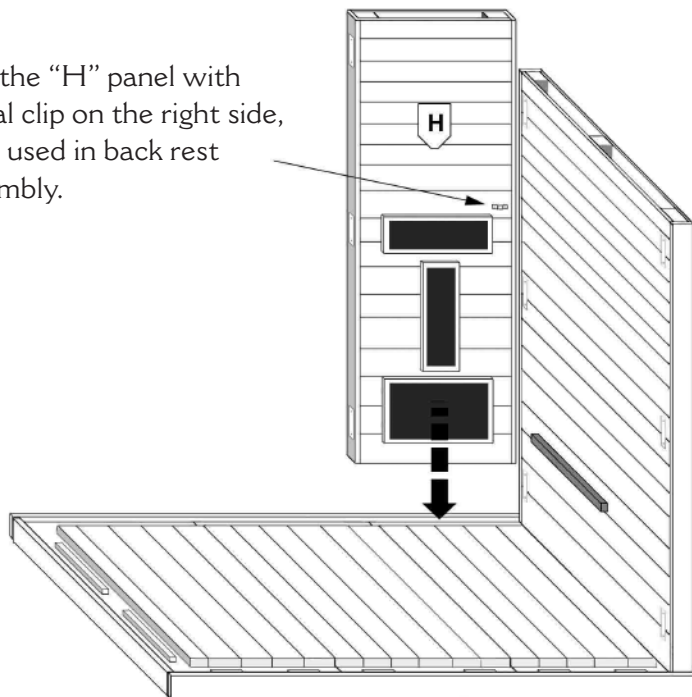

While one person holds the “J” panel in place, position the “H” heater panel into the back right base slot. The magnets in the walls will hold the walls in place.

IMPORTANT:
Each back panel “H” contains two (2) heater cords that must be pulled out of the top of the panels before installation.

5

Place two 12 inch "I" heater panels and remaining "H" heater panel onto sauna base. Magnets will hold your walls in place while you continue to build the sauna.

IMPORTANT:
Each back panel "H" & "I" contains two (2) heater cords that must be pulled out of the top of the panels before installation.

Notice metal clip positions for backrest on back wall. Do not get reversed.

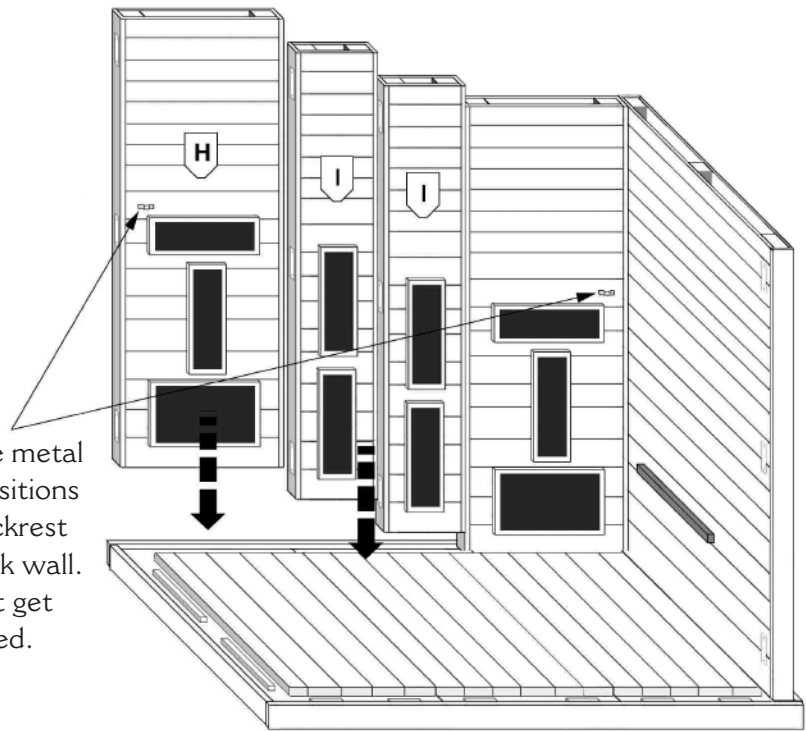

6

Place remaining "J" side wall in place.

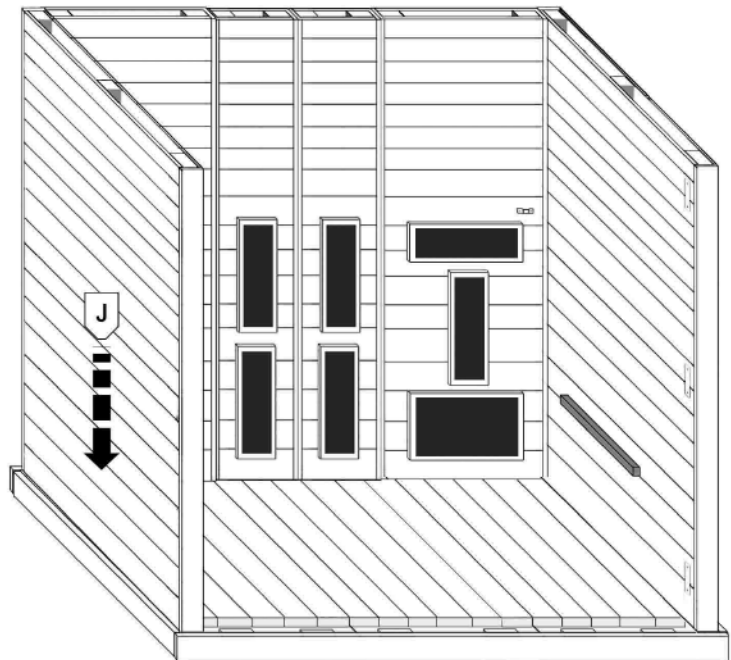

7

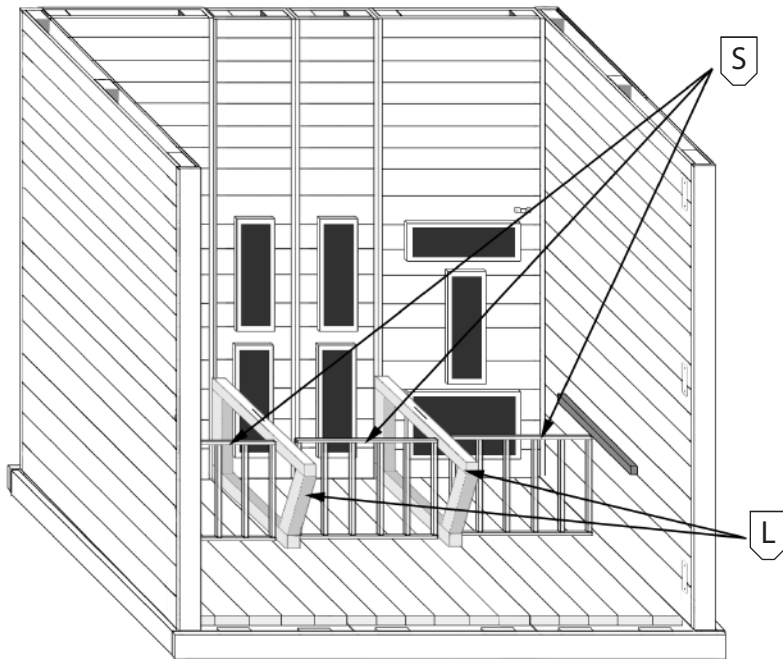

Place two bench supports "L" on to sauna floor.

Proceed to placing "S" heater guards into parallel slots located on side wall and middle "H" bench supports.

8

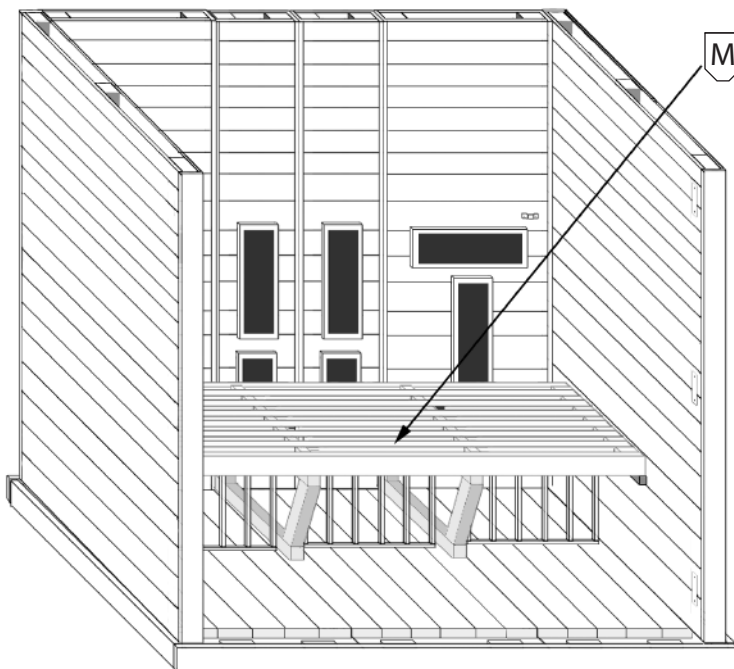

Place sauna bench "M" on support bars on side walls and center supports. Notice the wooden pegs on side wall supports and middle "M" bench supports. Wooden pegs will align with holes on the bottom of the bench.

9

Place backrest “N” onto the back walls of the sauna. Notice the metal hooks on the back side of the backrest slide into the metal brackets on the back walls of the sauna. The backrest will slide in behind the bench seat. This will secure your backrest to the sauna.

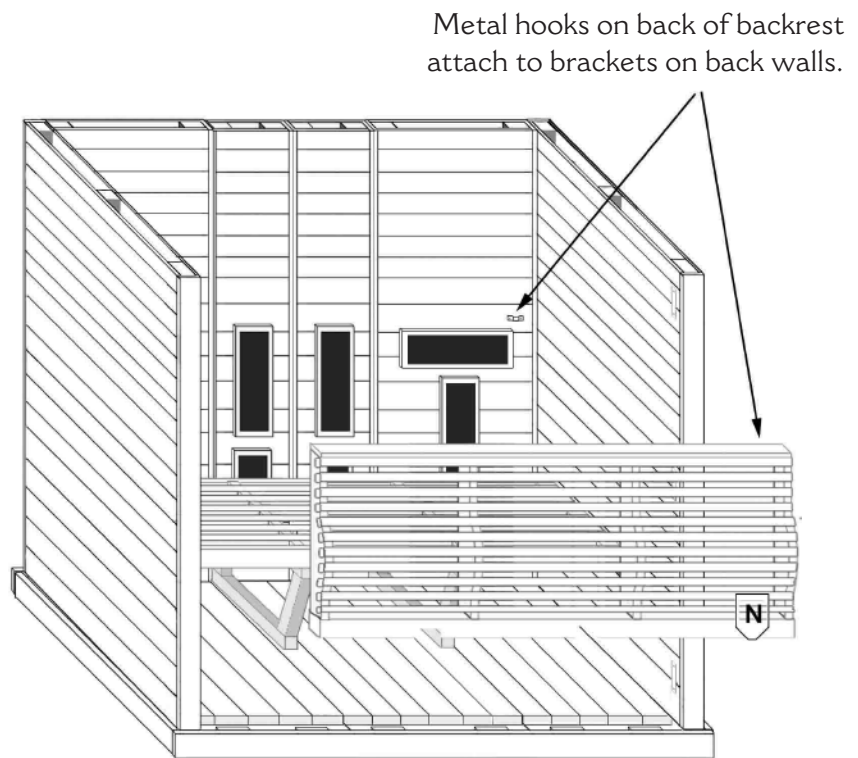

10

Insert window panel “K” into front base slot.

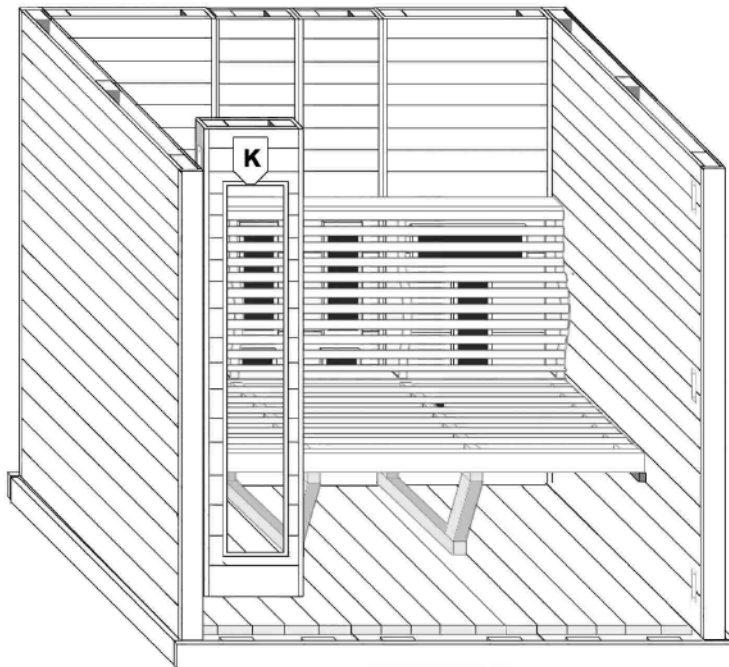

11

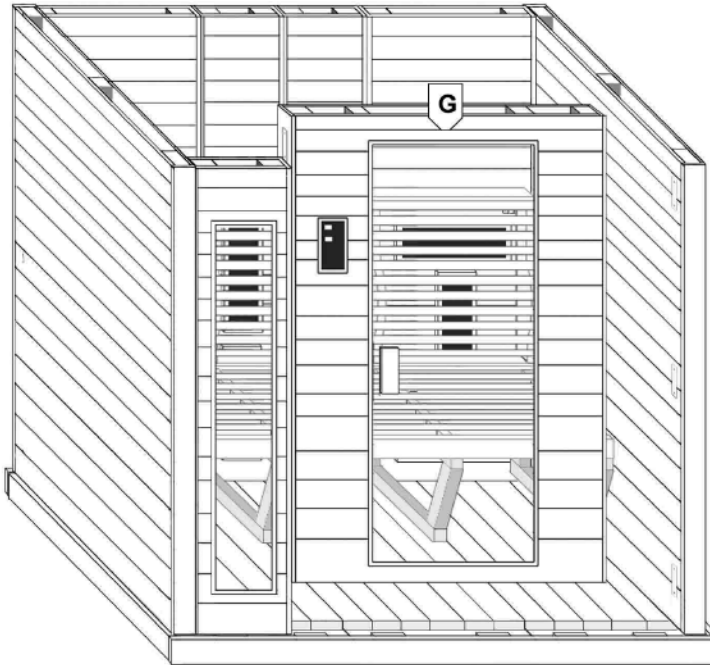

Insert door panel “G” into front base slot leaving a slight gap between wall panel. Cut securing strap on door panel and slide snugly against side panel.

WARNING:
THE ALL GLASS DOOR IS EXTREMELY HEAVY. IT IS IMPORTANT TO HAVE SOMEONE HOLD THIS IN PLACE WHILE THE ROOF PANEL IN SECTION 12 IS INSTALLED. ONCE ROOF PANEL IS INSTALLED, THE DOOR PANEL WILL BE SECURE.

12

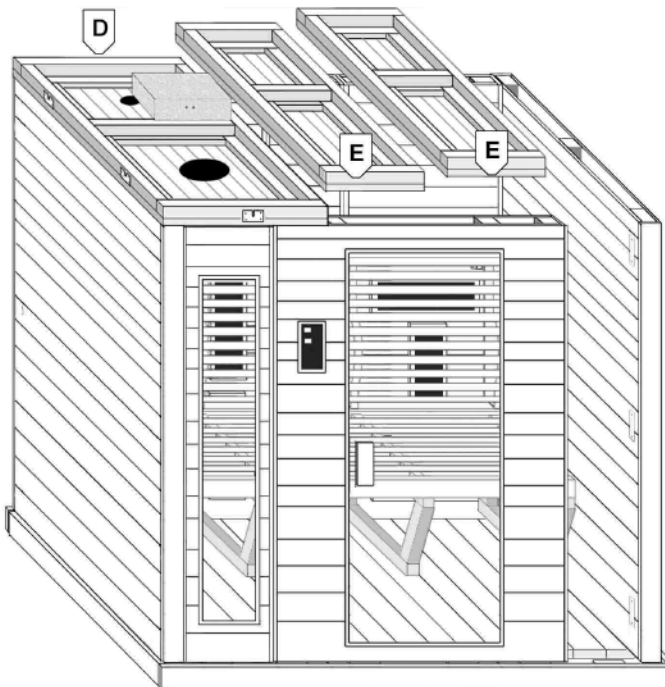

It is recommended to have two people while installing the ceiling. With speakers toward the front of the sauna, lift ceiling panel “D” over the top of the sauna using one person inside to guide the ceiling panel into place.

All cords from the walls must be placed over the exterior of the sauna.

Align cords with notches in the ceiling panel while inserting block pegs on ceiling panel snugly into wall.

Continue with “E” panel arranged so that buckles on top can be latched together.

13

Before finishing the ceiling panels, insert "K" window panel into base.

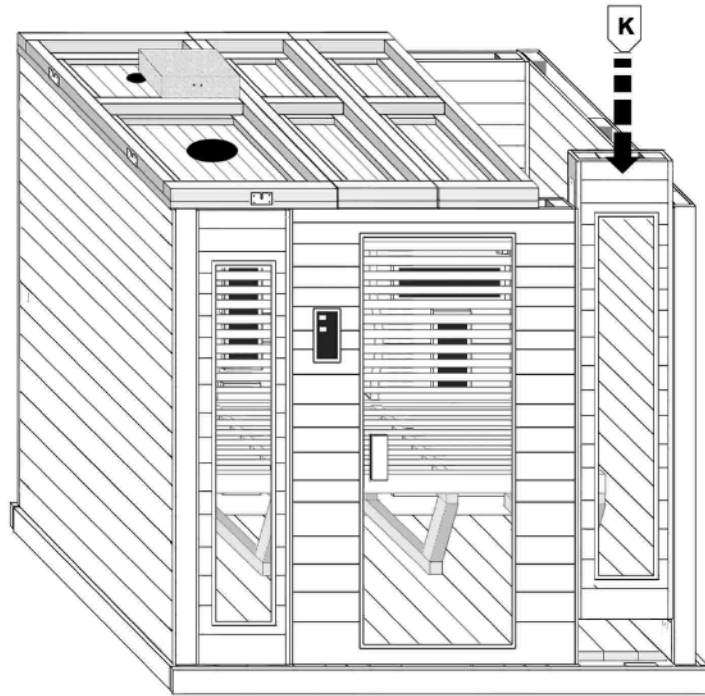

14

Insert remaining ceiling panel "F" following procedures listed in step 12.

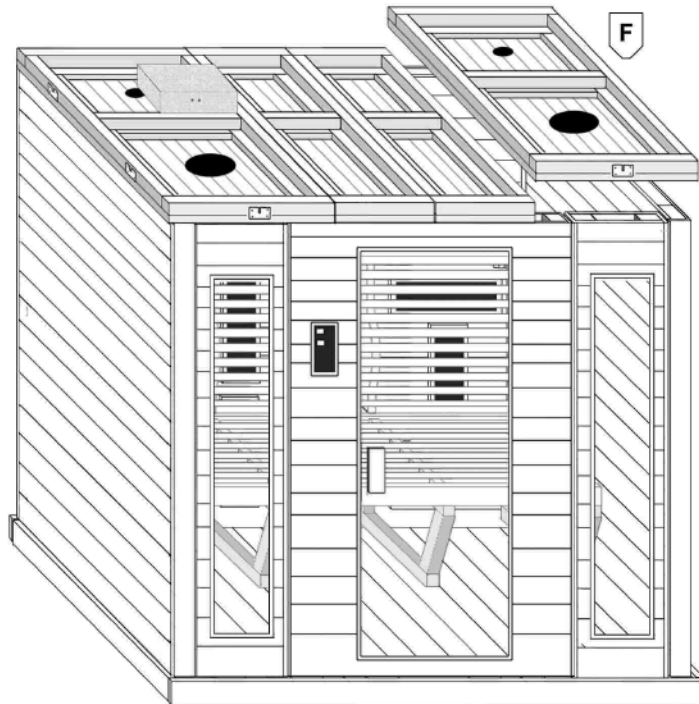

Buckles on roof panels lock ceiling together.

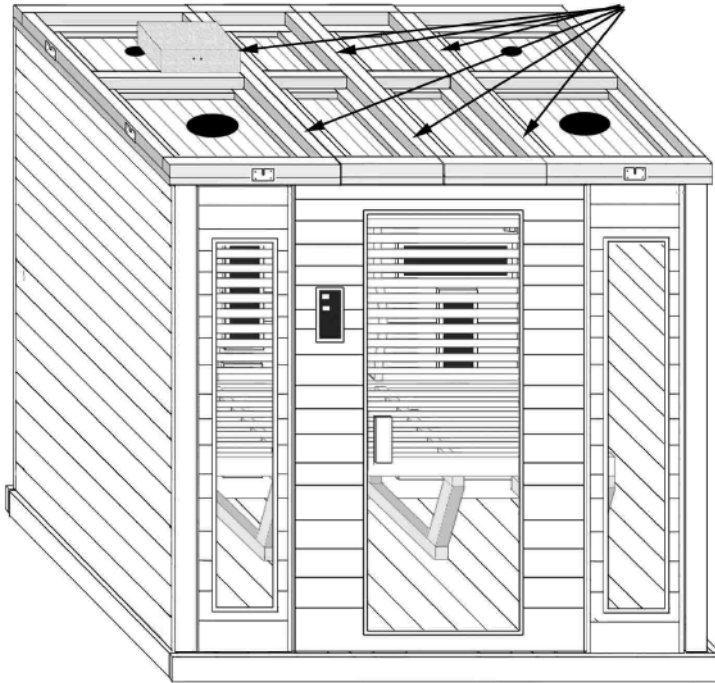

15

Buckle the three ceiling panels together with the four buckles located on the inside panel edges.

16

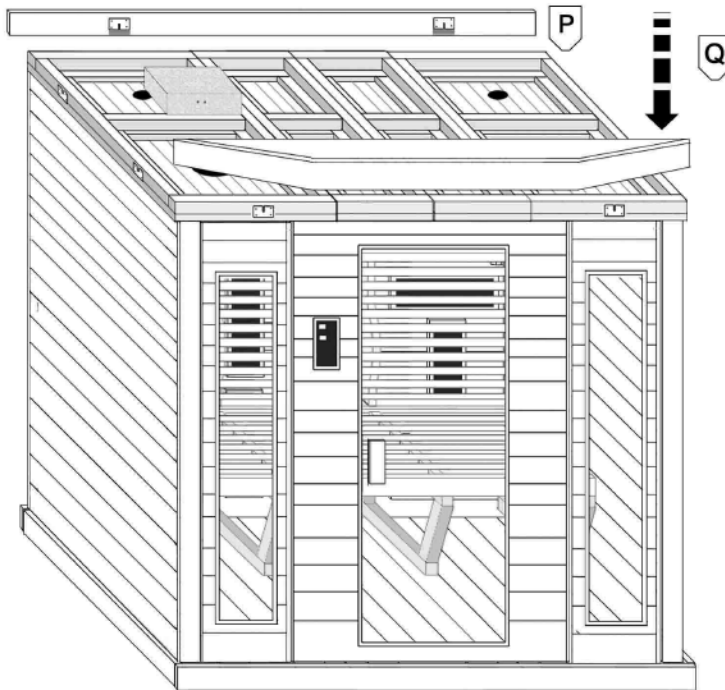

1. Install “Q” soffit using slide lock brackets on front of sauna. Align the slide locks just above the ceiling and pull down, connecting and locking the soffit into place.

2. Repeat for back trim “P”.

(Hint: If you are unable to join a pair of slide locks, use a Phillips head #2 screwdriver to slightly loosen the screws retaining the slide lock on the ceiling.)

17

Attach “O” trim boards on each side of sauna using the same slide locking method described in #16 to finish sauna construction.

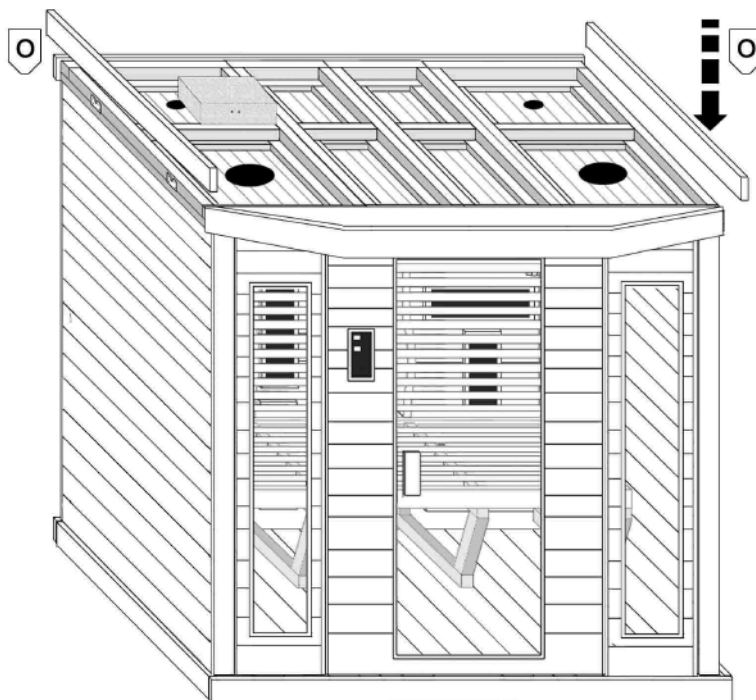

18

Construction of sauna complete. Begin plugging in components and heaters.



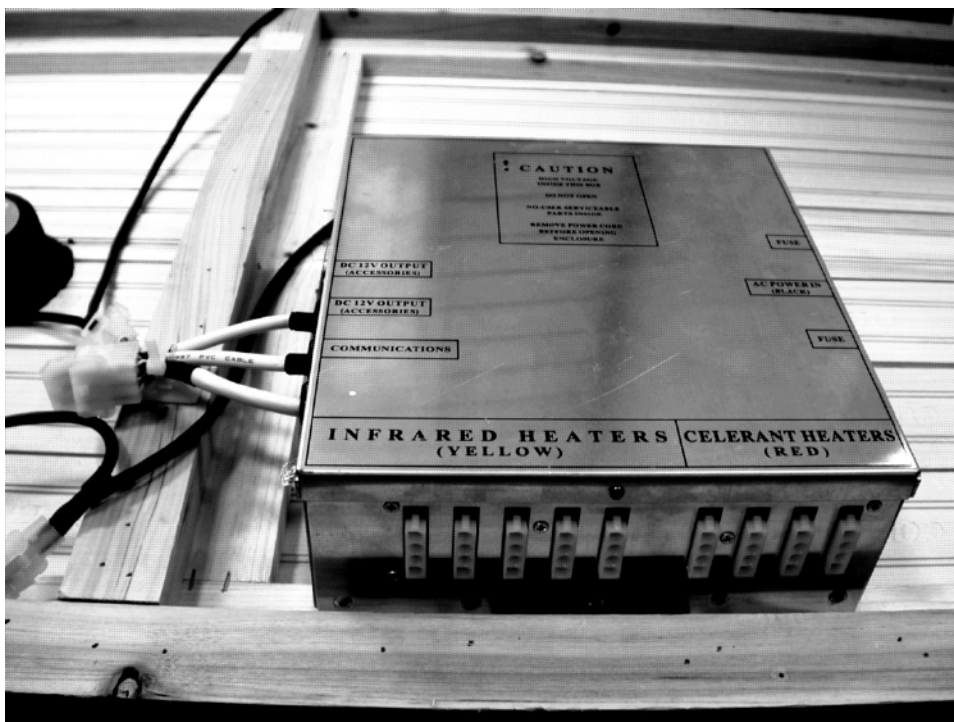

Connecting Heater Cables: Plug the wires coming from the top of the wall panels into the color-coded Therapy (Yellow 5 total) and Celerant (Red 4 total) ports.

2. Connecting the Power Cord: Connect the female end of the power cord into the corresponding AC POWER IN port on the control box. Plug the male end into any standard household outlet.

NOTE: It is suggested the outlet you choose be independent of any other electrical device.

WARNING:
NEVER ATTEMPT TO OPEN THE CONTROL BOX. OPENING THE CONTROL BOX WILL VOID THE WARRANTY AND MAY CAUSE A POTENTIALLY FATAL ELECTRICAL SHOCK.

I. CONNECTING SPEAKER WIRE:

Use the speaker wires provided. Starting with the left speaker, connect the striped wire to the (+) symbol and the remaining wire to the (-) symbol. Connect the remaining end to the red wire clamp on the amplifier and the other to the black clamp. Repeat for the right speaker.

2. CONNECTING RCA CABLES:

First, connect the provided RCA cable to the corresponding colored leads coming from the wall. Next, connect the other end to the corresponding colors on the amplifier. Note: The yellow lead coming from the wall will not be connected.

3. CONNECT THE LIGHT CABLES:

Join the 4 prong male connector into the receptacle cable coming from the control box. Connect ends of cables to lights.

4. AMP, IONIZER, DVD/TV:

Using the labeled 6 prong power cord for the amplifier, O3, and DVD/TV (optional), insert the male end of the cord into the corresponding female receptacle coming from the control box.

5. CONNECT THE CONTROL PANEL

by joining the 12 prong male connector coming from the front wall panel into the female receptacle cable coming from the control box.

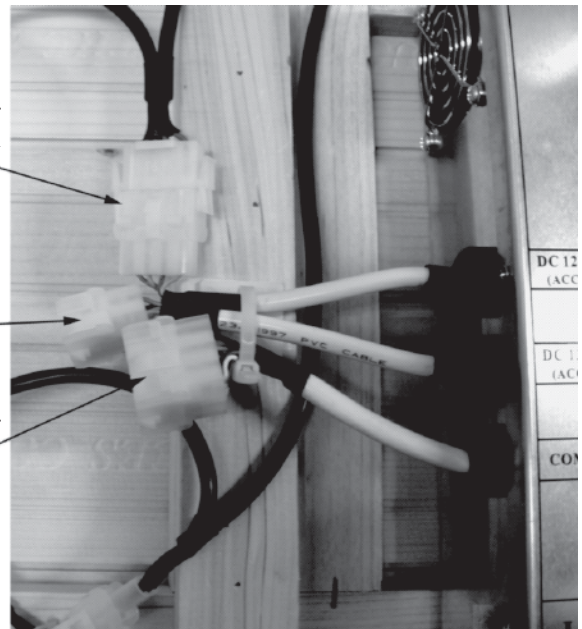
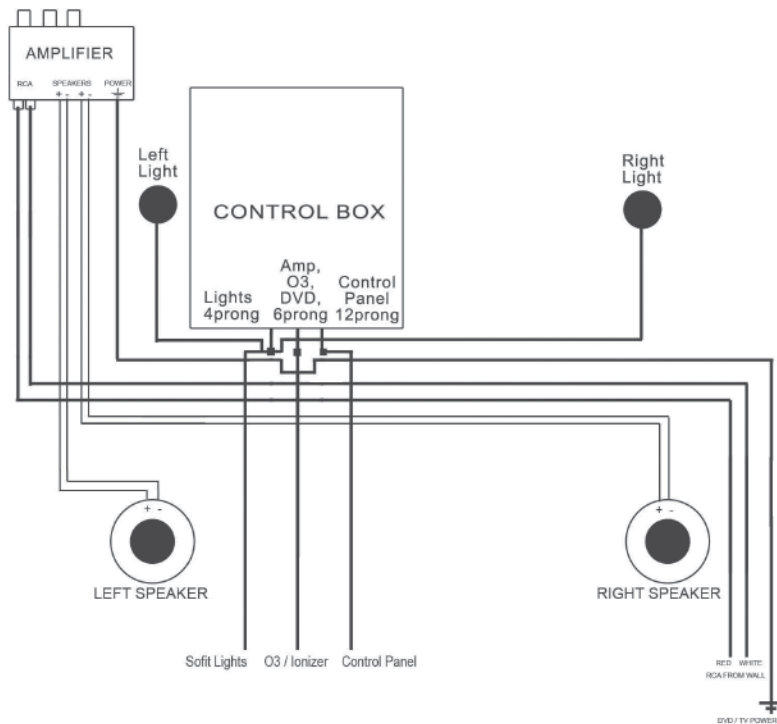

6 prong connection for Ionizer, Amplifier and optional DVD/LCD Power

4 prong connection for inside and outside lighting.

12 prong connection for control panel on front wall.

Accessories

Required tools. Drill bit and screw driver. It is essential to pre-drill all screw holes to prevent wood cracking and warranty issues.

Shelf Installation:

A small shelf has been provided for drinks or to place approved media devices on.

LCD/DVD Installation

LCD/DVD mount should be placed on wood block located left of door. Use the plastic mount as a guide to pre-drill holes. Once mounted, Set up LCD as shown in pictures on right to complete assembly.



Magazine Rack Install

Place magazine rack on one of the side walls just high enough that you avoid bumping into it when standing up. Pre-drill all holes into the sauna walls before putting screws into wood. This prevents any wood splitting and warranty issues.



Power cable for optional DVD Player only.

Pre-drill screws into wood block backing and install mount for DVD/LCD player

Shelf mount. Again, pre-drill holes for shelf mount system



CAUTION: Only use heat rated devices inside sauna. We do not assume liability for electronics that do not meet proper heat ratings for sauna use.